

# NJ.1250

 3/8"=9,52mm

			<ul style="list-style-type: none"><li>■ Clé à chocs pneumatique à renvoi d'angle</li><li>■ Impact wrench</li><li>■ Schlagschrauber</li></ul>
			<ul style="list-style-type: none"><li>■ Slagmoersleutel</li><li>■ Llave de impacto</li><li>■ Chiave a percussione</li></ul>

Notice d'instructions  
Instruction manual  
Bedienungsanleitung  
Gebruiksaanwijzing  
Manual de instrucción  
Istruzioni per l'utilizzo  
**NU-NJ.1250/98**

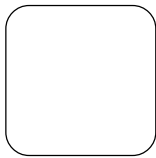

1,42 kg

3/8"

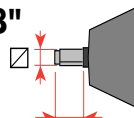

18,5 mm

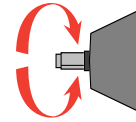

maxi 6000 t/mn

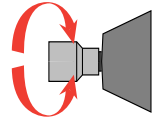

maxi 45 Nm

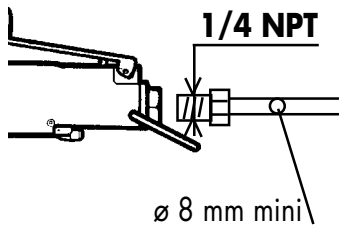

300 l/mn à 7 bar à vide  
200l/mn à 7 bar en charge

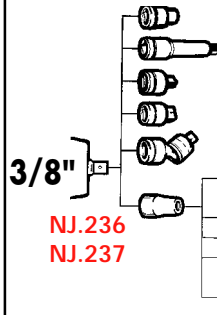

NJ.236  
NJ.237

NJ.6 -----19  
NJ.210 / NJ.211  
NJ.230  
NJ.232  
NJ.240

EP.  
ED.  
ES.  
ET. ou NJH.3 -----19  
EX.



92,5 dB(A)

22,30 m/s2



Inverseur  
Reverser  
Umschalter  
Omkeerschakelaar  
Engranaje inversor  
Invertitore



NJ.1250

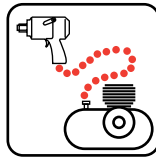
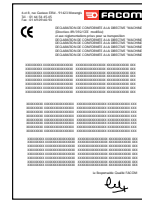
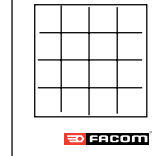

15 bar maxi /20°C  
10 bar maxi/60°C

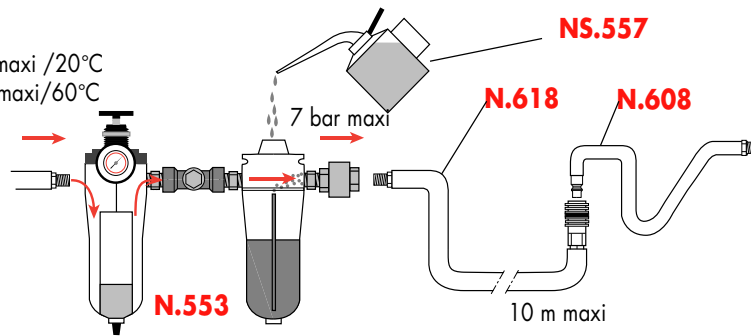

NJ.1250



BA.22  
GA.22

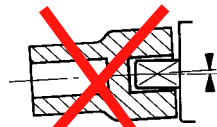

MINI 45 Nm



Porter des lunettes de sécurité  
Wear eye protectors  
Schutzbrille tragen  
Een veiligheidsbril dragen  
Utilizar gafas de seguridad  
Portare gli occhiali di sicurezza

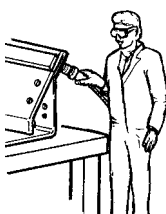

Pour garder la machine en bon état, remplacer les pièces d'usure toutes les 200 heures d'utilisation.

To keep the machine in proper working order, change wear parts after 200 hours to use.

Um die Maschine in gutem Zustand zu erhalten, Gebrauchsteile alle 200 Betriebsstunden austauschen.

Om deze machine in goede staat te houden, dienen de aan slijtage onderhevige onderdelen na 200 uren gebruik te worden verwisseld.

Para mantener la maquina en buen estado, cambiar las piezas de desgaste despues de 200 horas de utilizacion.

Per mantenere la macchina in buono stato, cambiare le parti d'usura dopo 200 ore di funzionamento.

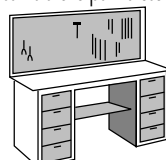

NJ.1000RN1

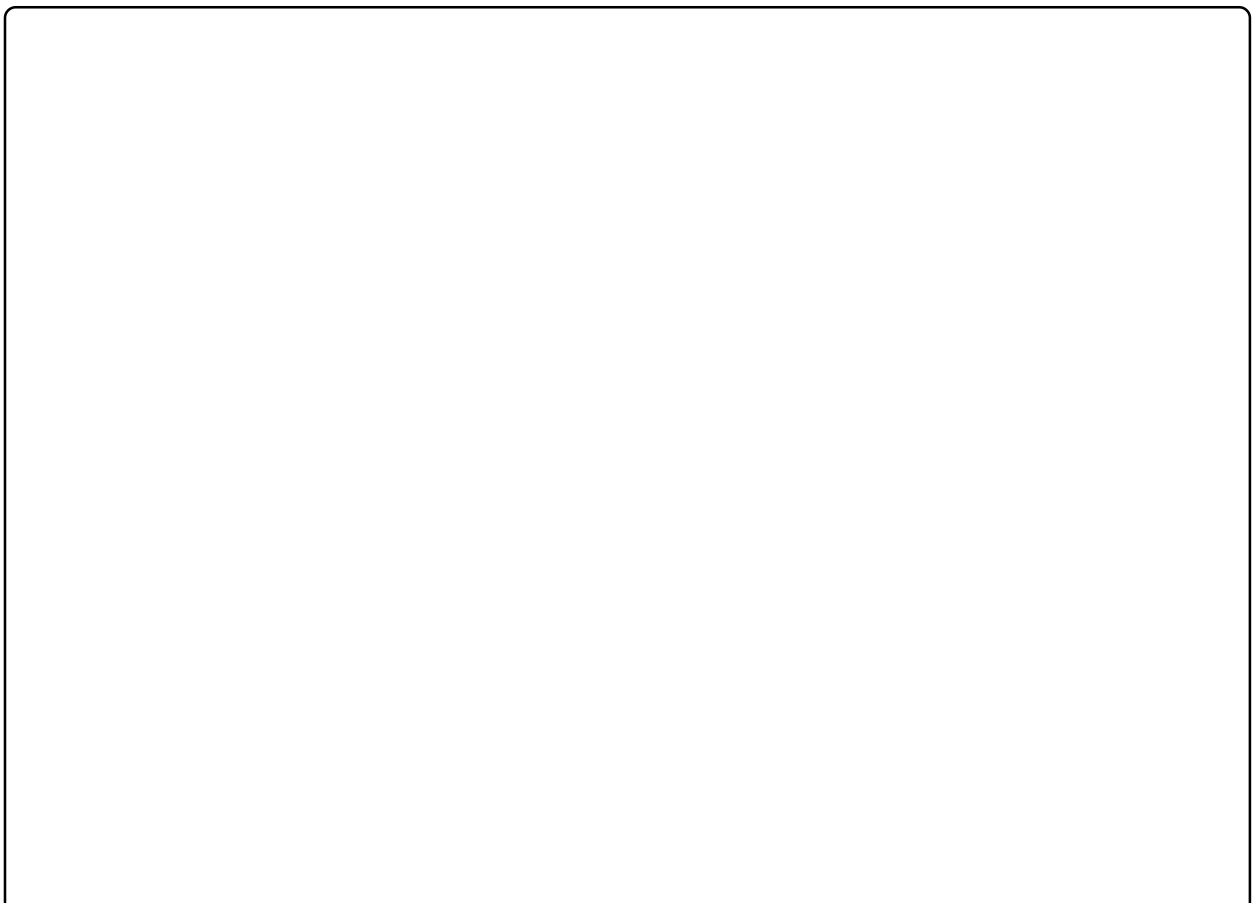
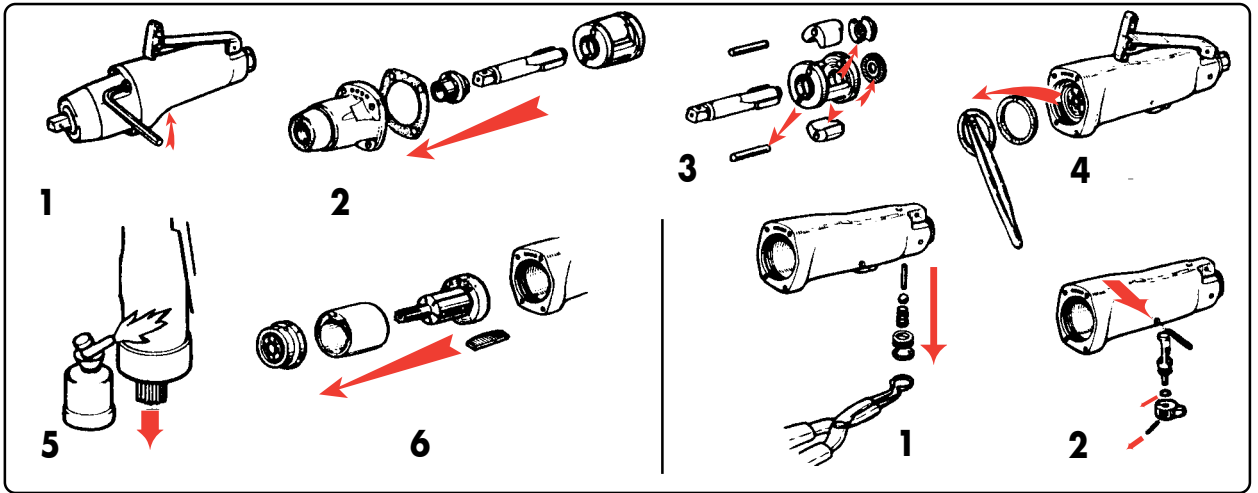
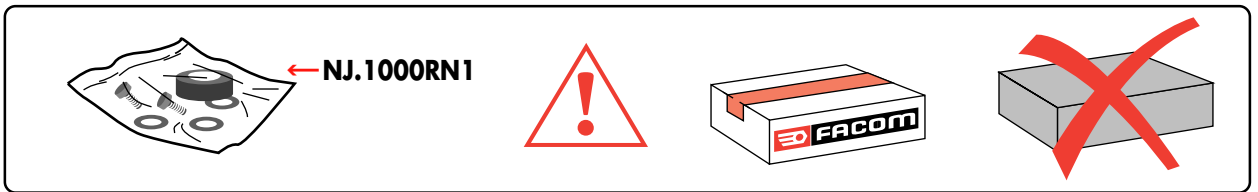
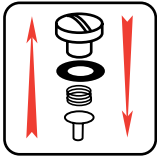

○	<b>NJ.1250</b>	○	<b>NJ.1250</b>	○	
①	NJ.1000RN1	13	ANNEAU.818-016	25	NJ.250-001
②	NJ.1000SE1	14	Goup.E1,5-6	26	Etc...
③	NJ.1000SE2	15	Goup.E,2-12		
④	NJ.1000SE3	16	Goup.E,2,5-26		
⑤	NJ.1000SE4	17	Goup.G6,3-22		
⑥	NJ.1000SE5	18	BAGUE.R00640-190		
⑦	NJ.1000SE6	19	BAGUE.R01160-240		
⑧	NJ.1000SE7	20	BAGUE.R01600-250		
9	NJ.1000-002	21	ROULEMENT.608		
10	NJ.1000-001	22	ROULEMENT.629		
11	NJ.1000-044	23	ROND.WZ4		
⑫	NJ.1000RN3	24	VIS.CHc,M4-15		
					(4)
					(4)

**BELGIQUE** FACOM Belgique S.A./NV  
**LUXEMBOURG** Weihoek 4  
1930 Zaventem  
BELGIQUE  
☎ : (02) 714 09 00  
Fax : (02) 721 24 11

**DANMARK** FACOM NORDEN A/S

**FINLAND** Navervej 16B

**ISLAND** 7451 SUNDS

**NORGE** DANMARK

**SVERIGE** ☎ : (45) 971 444 55

Fax : (45) 971 444 66

**DEUTSCHLAND** FACOM GmbH

Postfach 13 22 06

42049 Wuppertal



Otto-Wells-Straße 9

42111 Wuppertal



DEUTSCHLAND

☎ : (0202) 270 63 0

Fax : (0202) 270 63 50

**ESPAÑA** FACOM Herramientas SRL

**PORTUGAL** Poligono industrial de Vallecas

C/.Luis 1º, s/n-Nave 95 - 2ºPl.

28031 Madrid

ESPAÑA

☎ : (91) 778 21 13

Fax : (91) 778 27 53

**ITALIA** U.A. FACOM Italia

Via Volta 3

21020 Monvalle (VA)

ITALIA

☎ : (0332) 790 111

Fax : (0332) 790 602

**NEDERLAND** FACOM Gereedschappen BV

Kamerlingh Onnesweg 2

Postbus 134

4130 EC Vianen

NEDERLAND

☎ : (0347) 372 334

Fax : (0347) 376 020

**SINGAPORE** FACOM Tools FAR EAST Pte Ltd

**FAR EAST** 15 Scotts Road

Thong Teck Building #08.01.02

Singapore 228218

SINGAPORE

☎ : (65) 732 0552

Fax : (65) 732 5609

**SUISSE** FACOM S.A./AG

**ÖSTERREICH** 12 route Henri-Stéphan

**MAGYARORSZÁG** 1762 Givisiez/Fribourg

**ISRAËL** SUISSE

☎ : (4126) 466 42 42

Fax : (4126) 466 38 54

**UNITED** FACOM Tools LTD

**KINGDOM** Bridge Wharf - Bridge Road

**EIRE** CHERTSEY - SURREY KT16-8LJ

UNITED KINGDOM

☎ : (01932) 566 099

Fax : (01932) 562 653

**UNITED** FACOM TOOLS Inc.

**STATES** 3535 West 47th Street

Chicago Illinois 60632

U.S.A.

☎ : (773) 523 1307

Fax : (773) 523 2103

**FRANCE** Société FACOM

**&** 6-8, rue Gustave Eiffel B.P.99

**INTERNATIONAL** 91423 Morangis cedex

FRANCE

☎ : 01 64 54 45 45

Fax : 01 69 09 60 93

<http://www.facom.fr>

