

# WV.1109

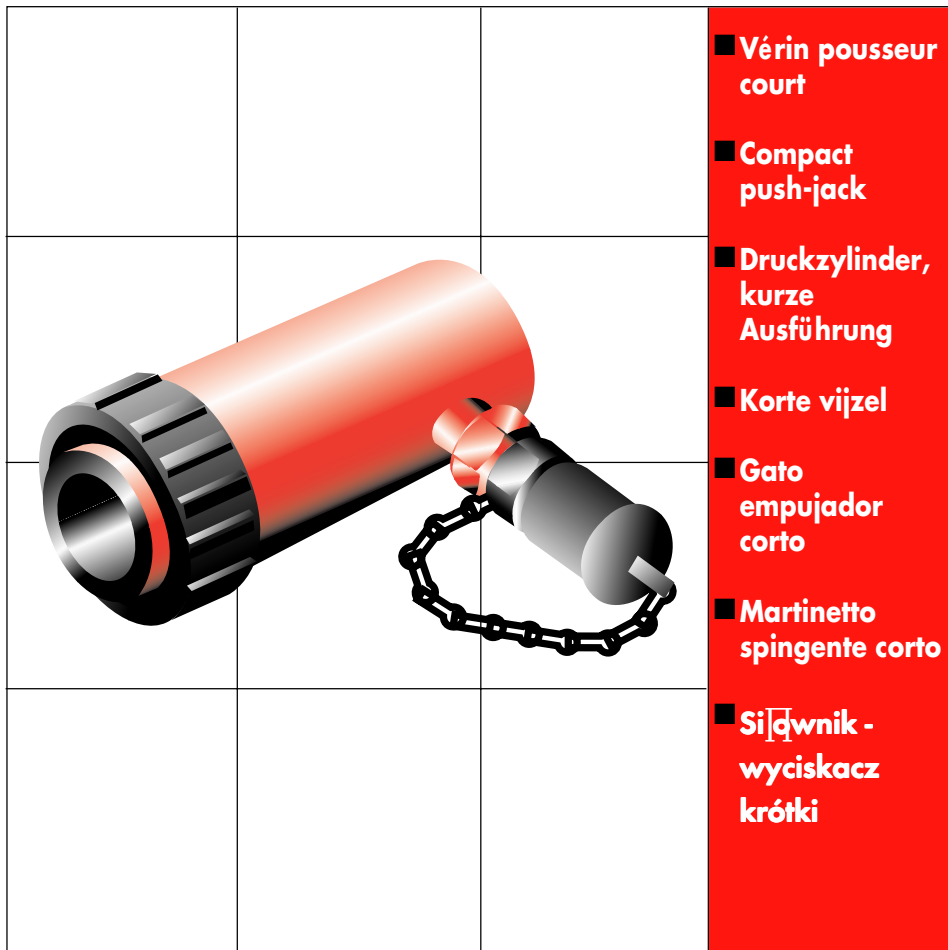

Notice d'instructions  
Instruction manual  
Bedienungsanleitung  
Gebruiksaanwijzing  
Guia de instrucciones  
Istruzioni per l'utilizzo  
Instrukcja obsługi

**NU-WV.1109/0703**

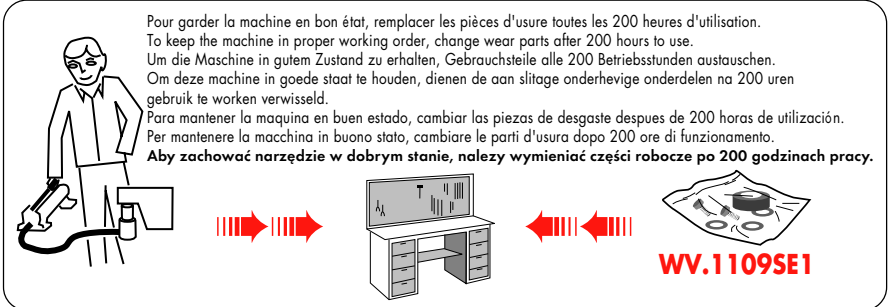
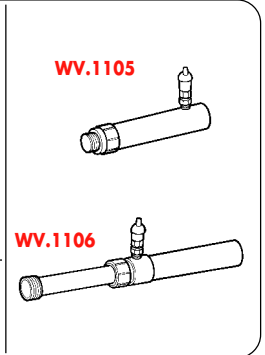
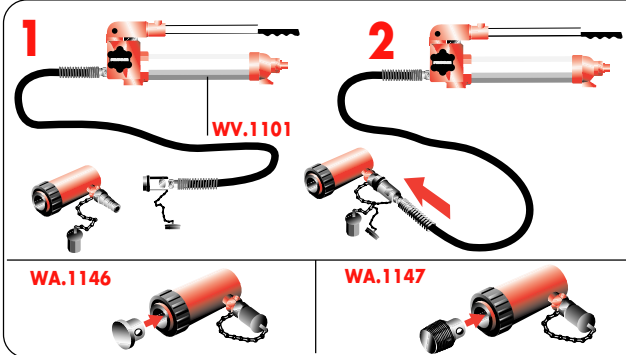
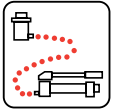
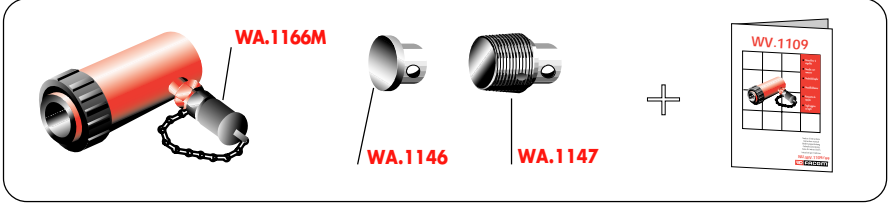
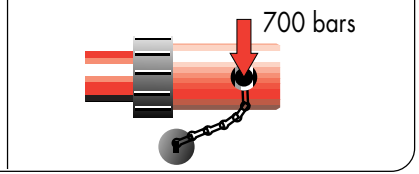
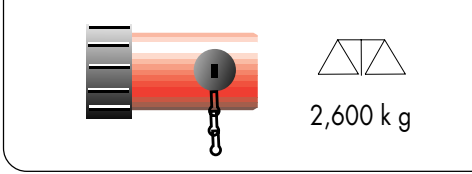
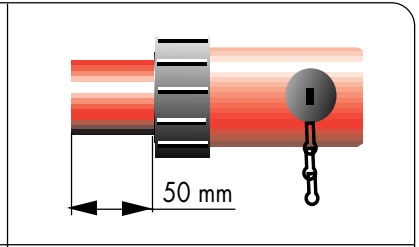
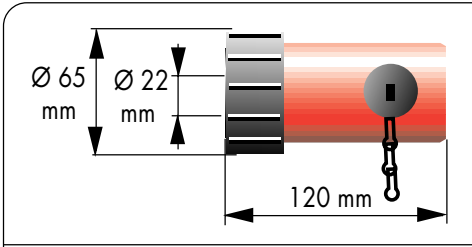

Pour garder la machine en bon état, remplacer les pièces d'usure toutes les 200 heures d'utilisation.

To keep the machine in proper working order, change wear parts after 200 hours to use.

Um die Maschine in gutem Zustand zu erhalten, Gebrauchsteile alle 200 Betriebsstunden austauschen.

Om deze machine in goede staat te houden, dienen de aan slijtage onderhevige onderdelen na 200 uren gebruik te worden verwisseld.

Para mantener la máquina en buen estado, cambiar las piezas de desgaste después de 200 horas de utilización.

Per mantenere la macchina in buono stato, cambiare le parti d'usura dopo 200 ore di funzionamento.

Aby zachować narzędzie w dobrym stanie, należy wymieniać części robocze po 200 godzinach pracy.

**WV.1109SE1**

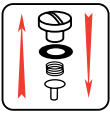

**WV.1109SE1**

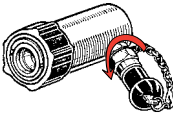
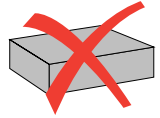

**1**

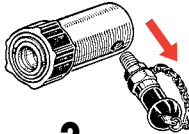

**2**



**3**

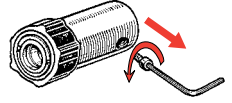

**4**

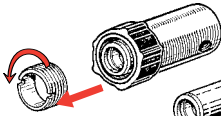

**5**

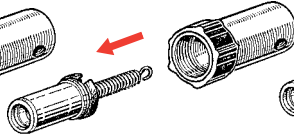

**6**

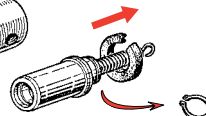

**7**

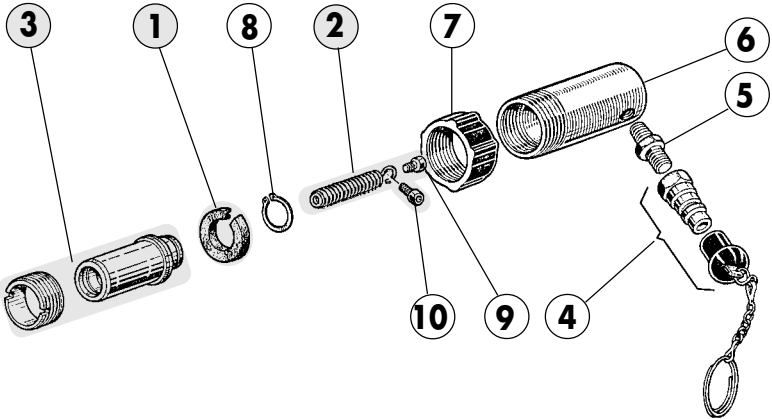

①	WV.1105RN	⑥	WV.1105C03
②	WV.1109SE1	⑦	WV.1105-09
③	WV.1109SE2	⑧	ANNEAU.81-0280
④	WA.1166M	⑨	VIS.CHC,M8-14
⑤	WA.1168	⑩	VIS.CHC,M8-25

**BELGIQUE** FACOM Belgique S.A./NV  
**LUXEMBOURG** Weihoek 4  
1930 Zaventem  
BELGIQUE  
☎ : (02) 714 09 00  
fax : (02) 721 24 11

**DANMARK** FACOM NORDEN A/S  
**FINLAND** Navervej 16 B  
**ISLAND** 7451 SUND  
**NORGE** DANMARK  
**SVERIGE** ☎ : (45) 97 14 44 55  
fax : (45) 97 14 44 66

**DEUTSCHLAND** FACOM GmbH  
Postfach 13 22 06   
42049 Wuppertal  
Otto-Wels-Straße 9   
42111 Wuppertal  
DEUTSCHLAND  
☎ : (0202) 270 63 0  
fax : (0202) 270 63 50

**ESPAÑA** FACOM Herramientas, S.L  
**PORTUGAL** Poligono industrial de Vallecas  
C/.Luis 1° s/n-Nave 95-2° Pl.  
28031 Madrid  
ESPAÑA  
☎ : (0034) 91 778 21 13  
fax : (0034) 91 778 27 53

**ITALIA** USAG Gruppo FACOM  
Via Volta 3  
21020 Monvalle(VA)  
ITALIA  
☎ : (0332) 790 111  
fax : (0332) 790 602

**POLSKA** FACOM TOOLS POLSKA SP.ZO.O.  
ul.Marconich 9 m.3  
02-954 Warszawa  
POLSKA  
☎ : (0048 22) 642 71 14  
Fax : (0048 22) 651 74 69

**NEREDLAND** FACOM Gereedschappen BV  
Kamerlingh Onnesweg 2  
Postbus 134  
4130 EC Vianen  
NEREDLAND  
☎ : (0347) 362 362  
fax : (0347) 376 020

**SINGAPORE** FACOM TOOLS FAR EAST Pte Ltd  
**FAR EAST** 15 Scotts Road  
Thong Teck Building # 08.01.02  
Singapore 228218  
SINGAPORE  
☎ : (65) 732 0552  
fax : (65) 732 5609

**SUISSE** FACOM S.A./AG  
**ÖSTERREICH** 12 route Henri-Stéphan  
**MAGYARORSZAG** 1762 Givisiez/Fribourg  
**CESKA REP.** SUISSE  
☎ : (4126) 466 42 42  
fax : (4126) 466 38 54

**UNITED** FACOM - UK  
**KINGDOM** Churchbridge Works - Walsall road  
**EIRE** CANNOCK - STAFFORDSDHIRE S1 3JR  
UNITED KINGDOM  
☎ : (01922) 702 150  
fax : (01922) 702 152

**UNITED** FACOM TOOLS Inc.  
**STATES** 3535 West 47th Street  
Chicago Illinois 60632  
U.S.A.  
☎ : (773) 523 1307  
fax : (773) 523 2103

**FRANCE** Société FACOM  
**&** 6-8 rue Gustave Eiffel BP.99  
**INTERNATIONAL** 91420 Morangis Cedex  
FRANCE  
☎ : 01 64 54 45 45  
fax : 01 69 09 60 93  
<http://www.facom.fr>

*En France, pour tous renseignements techniques sur l'outillage à mains, téléphonez au 01 64 54 45 14.*

